

UIB30 and UIB30H
Sealed Inverted Bucket Steam Traps
for use with Pipeline Connectors
Installation and Maintenance Instructions

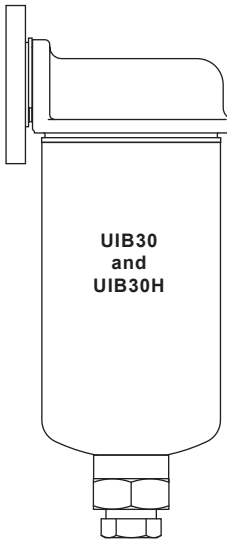

1. Safety information
2. General product information
3. Installation
4. Commissioning
5. Operation
6. Maintenance
7. Spare parts

1. Safety information

Safe operation of these products can only be guaranteed if they are properly installed, commissioned, used and maintained by qualified personnel (see Section 1.11) in compliance with the operating instructions. General installation and safety instructions for pipeline and plant construction, as well as the proper use of tools and safety equipment must also be complied with.

Warning

The inner and outer gaskets used when installing/maintaining the UIB to a PC_ pipeline connector contain thin stainless steel support rings which may cause physical injury if not handled and disposed of carefully.

1.1 Intended use

Referring to the Installation and Maintenance Instructions, product marking and Technical Information Sheet, check that the product is suitable for the intended use/application. The UIB30 and UIB30H comply with the requirements of the Pressure Equipment Directive (PED) and fall within category 'SEP'.

It should be noted that products within this category are required by the Directive not to carry the  mark.

- i) The product has been specifically designed for use on steam, compressed air and water/condensate which are in Group 2 of the above mentioned Pressure Equipment Directive.
- ii) Check material suitability, pressure and temperature and their maximum and minimum values. If the maximum operating limits of the product are lower than those of the system in which it is being fitted, or if malfunction of the product could result in a dangerous overpressure or overtemperature occurrence, ensure a safety device is included in the system to prevent such over-limit situations.
- iii) Determine the correct installation situation and direction of fluid flow.
- iv) Spirax Sarco products are not intended to withstand external stresses that may be induced by any system to which they are fitted. It is the responsibility of the installer to consider these stresses and take adequate precautions to minimise them.
- v) Remove protection covers from all connections and protective film from all name-plates, where appropriate, before installation on steam or other high temperature applications.

1.2 Access

Ensure safe access and if necessary a safe working platform (suitably guarded) before attempting to work on the product. Arrange suitable lifting gear if required.

1.3 Lighting

Ensure adequate lighting, particularly where detailed or intricate work is required.

1.4 Hazardous liquids or gases in the pipeline

Consider what is in the pipeline or what may have been in the pipeline at some previous time. Consider: flammable materials, substances hazardous to health, extremes of temperature.

1.5 Hazardous environment around the product

Consider: explosion risk areas, lack of oxygen (e.g. tanks, pits), dangerous gases, extremes of temperature, hot surfaces, fire hazard (e.g. during welding), excessive noise, moving machinery.

1.6 The system

Consider the effect on the complete system of the work proposed. Will any proposed action (e.g. closing isolation valves, electrical isolation) put any other part of the system or any personnel at risk? Dangers might include isolation of vents or protective devices or the rendering ineffective of controls or alarms. Ensure isolation valves are turned on and off in a gradual way to avoid system shocks.

1.7 Pressure systems

Ensure that any pressure is isolated and safely vented to atmospheric pressure. Consider double isolation (double block and bleed) and the locking or labelling of closed valves. Do not assume that the system has depressurised even when the pressure gauge indicates zero.

1.8 Temperature

Allow time for temperature to normalise after isolation to avoid the danger of burns.

1.9 Tools and consumables

Before starting work ensure that you have suitable tools and /or consumables available. Use only genuine Spirax Sarco replacement parts.

1.10 Protective clothing

Consider whether you and/or others in the vicinity require any protective clothing to protect against the hazards of, for example, chemicals, high/low temperature, radiation, noise, falling objects, and dangers to eyes and face.

1.11 Permits to work

All work must be carried out or be supervised by a suitably competent person. Installation and operating personnel should be trained in the correct use of the product according to the Installation and Maintenance Instructions. Where a formal 'permit to work' system is in force it must be complied with. Where there is no such system, it is recommended that a responsible person should know what work is going on and, where necessary, arrange to have an assistant whose primary responsibility is safety. Post 'warning notices' if necessary.

1.12 Handling

Manual handling of large and/or heavy products may present a risk of injury. Lifting, pushing, pulling, carrying or supporting a load by bodily force can cause injury particularly to the back. You are advised to assess the risks taking into account the task, the individual, the load and the working environment and use the appropriate handling method depending on the circumstances of the work being done.

1.13 Residual hazards

In normal use the external surface of the product may be very hot. If used at the maximum permitted operating conditions the surface temperature of the product may reach temperatures up to 425 °C (797 °F).

Many products are not self-draining. Take due care when dismantling or removing the product from an installation (refer to 'Maintenance instructions').

1.14 Freezing

Provision must be made to protect products which are not self-draining against frost damage in environments where they may be exposed to temperatures below freezing point.

1.15 Disposal

Unless otherwise stated in the Installation and Maintenance Instructions, this product is recyclable and no ecological hazard is anticipated with its disposal providing due care is taken.

1.16 Returning products

Customers and stockists are reminded that under EC Health, Safety and Environment Law, when returning products to Spirax Sarco they must provide information on any hazards and the precautions to be taken due to contamination residues or mechanical damage which may present a health, safety or environmental risk. This information must be provided in writing including Health and Safety data sheets relating to any substances identified as hazardous or potentially hazardous.

2. General product information

2.1 General description

The UIB30 and UIB30H are sealed inverted bucket steam traps for either horizontal or vertical installation (with the cover hanging downwards). The UIB30H is designed for higher capacities. When installed with a suitable pipeline connector (available separately from Spirax Sarco) the UIB can easily and simply be removed without breaking into the pipeline, thus speeding up trap replacement with minimal system downtime. Pipeline connectors are available with screwed, socket weld and flanged end connections. The body and cover meet typical industry standards including Charpy testing of 27J @ -30 °C.

Standards

This product fully complies with the requirements of the Pressure Equipment Directive (PED).

Certification

This product is available with certification to EN 10204 3.1.

Note: All certification/inspection requirements must be specified at the time of order placement.

Note: For additional information see Technical Information Sheet: **TI-P113-01** for the UIB30 and UIB30H.

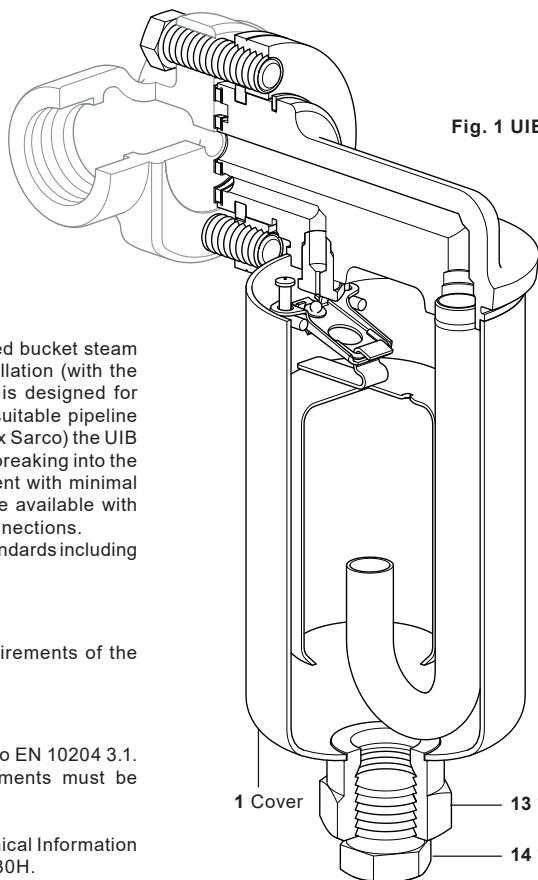

* Optional extras

See page 9

2.2 Sizes and pipe connections

The UIB30 and UIB30H can be fitted to a variety of different pipeline connectors including:-

PC10HP	Straight connector	ASME 600	(see TI-P128-10)
PC20	Connector with 'Y' type strainer	ASME 300	(see TI-P128-15)
PC30	Connector with one piston isolation valve	ASME 600	(see TI-P128-02)
PC40	Connector with two piston isolation valves	ASME 600	(see TI-P128-03)

See the relevant Technical Information Sheet as listed above for details of the connections available on pipeline connectors.

2.3 Pressure/temperature limits

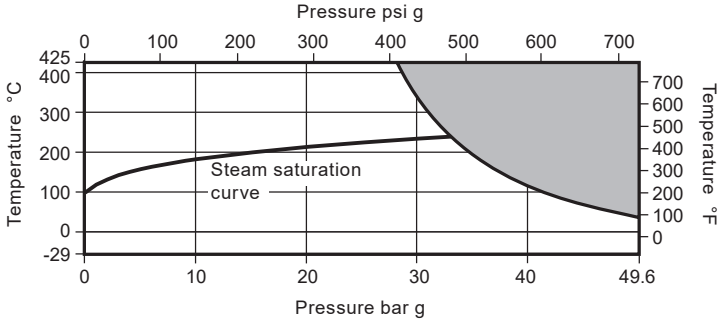

The product **must not** be used in this region.

Note: The model of pipeline connector and connections selected will dictate the maximum operating pressure and temperature of the complete assembly. Consult the specified Technical Information Sheet for this information (see Section 2.2).

Body design conditions			ASME 300	
PMA	Maximum allowable pressure	49.6 bar g @ 38 °C	(720 psi g @ 100 °F)	
TMA	Maximum allowable temperature	425 °C @ 28 bar g	(800 °F @ 405 psi g)	
Minimum ambient temperature			-30 °C (-22 °F)	
PMO	Maximum operating pressure for saturated steam service	32 bar g	(464 psi)	
TMO	Maximum operating temperature	425 °C @ 28 bar g	(800 °F @ 405 psi g)	
Minimum operating temperature			0 °C (32 °F)	
ΔPMX	Maximum differential pressure	UIB30/4	UIB30H/5	30 bar (435 psi)
		UIB30/5	UIB30H/6	20 bar (290 psi)
		UIB30/6	UIB30H/7	12 bar (174 psi)
		UIB30/7	UIB30H/8	8.5 bar (123 psi)
			UIB30H/10	5 bar (72.5 psi)
		UIB30/8		4 bar (58 psi)
		UIB30/10		2.5 bar (36 psi)
			UIB30H/12	2 bar (29 psi)
		UIB30/12		1.5 bar (22 psi)
Designed for a maximum cold hydraulic test pressure of:			75 bar g (1088 psi g)	

3. Installation

Note: Before actioning any installation observe the 'Safety information' in Section 1.

Referring to the Installation and Maintenance Instructions, name-plate and Technical Information Sheet, check that the product is suitable for the intended installation:

- 3.1** Check materials, pressure and temperature and their maximum values. If the maximum operating limit of the product is lower than that of the system in which it is being fitted, ensure that a safety device is included in the system to prevent overpressurisation.
- 3.2** Determine the correct installation situation and the direction of fluid flow.
- 3.3** Remove protection covers from all connections and protective film from all name-plates, where appropriate, before installation on steam or other high temperature applications.
- 3.4** If the trap has been supplied with a drain plug and is to be replaced with a drain device, this should be completed before fixing the trap to the pipeline connector. When removing the plug or assembling a drain device, suitable spanners must be used on the drain connection flats (13) and the drain plug flats (14).
- 3.5** The UIB can be installed on any pipeline connector. See separate Installation and Maintenance Instructions for Spirax Sarco pipeline connectors (IM-P128-06, IM-P128-11 and IM-P128-13). Ensure that both gaskets are clean and undamaged and that the transfer holes are clear. Place the UIB body against the connector gasket face, ensuring that the trap itself is vertical so the bucket always rises and falls in a vertical plain.
Ensuring the new connector screws supplied with the trap are used, apply a suitable amount of anti-seize thread lubricant to the threads of the connector screws (10). Tighten the screws finger tight until the mating gasket faces are in parallel, intimate contact. Tighten the screws evenly and gradually to the recommended torque value (see Table 1). Open isolation valves slowly until normal operating conditions are achieved.
- 3.6** Inverted bucket steam traps do not permit rapid release of air. On process applications, in particular, this can lead to slow warm-up times and waterlogging of the steam space. A separate external air vent is therefore required in parallel to vent air efficiently. Any bypass should be positioned above the trap. If it is below, and is leaking or left open, the waterseal could be blown away leading to steam wastage. Where inverted bucket traps are fitted in exposed conditions the possibility of freezing damage can be reduced by thermal insulation.
- 3.7** The inlet of the trap should be below the drain point of the plant being drained, so that a waterseal can be maintained around the open end of the bucket. When installed in a horizontal pipeline a small drop leg should precede the trap - typically 150 mm (6").
- 3.8** Where the trap discharges into a closed condensate return system or where there is a lift at the trap, a check valve should be fitted downstream of the trap.
- 3.9** If the trap has to be installed at a higher point than the drainage point, then a small bore riser into a 'U' seal should be used. A check valve should be fitted before the trap to prevent the loss of the internal waterseal.
- 3.10** If the trap is installed on a superheated steam system application, then a non return valve should be fitted on the trap inlet, to prevent the trap from losing its waterseal.
Priming of the trap with water may be required before commissioning.
- 3.11** Check for leaks.

Note 1: If the trap is to discharge to atmosphere ensure it is to a safe place, the discharging fluid may be at a temperature of 100 °C (212 °F).

Note 2: On all blast discharge steam traps check valves and sight glasses must be installed at least 1 metre (3 ft) downstream of the trap.

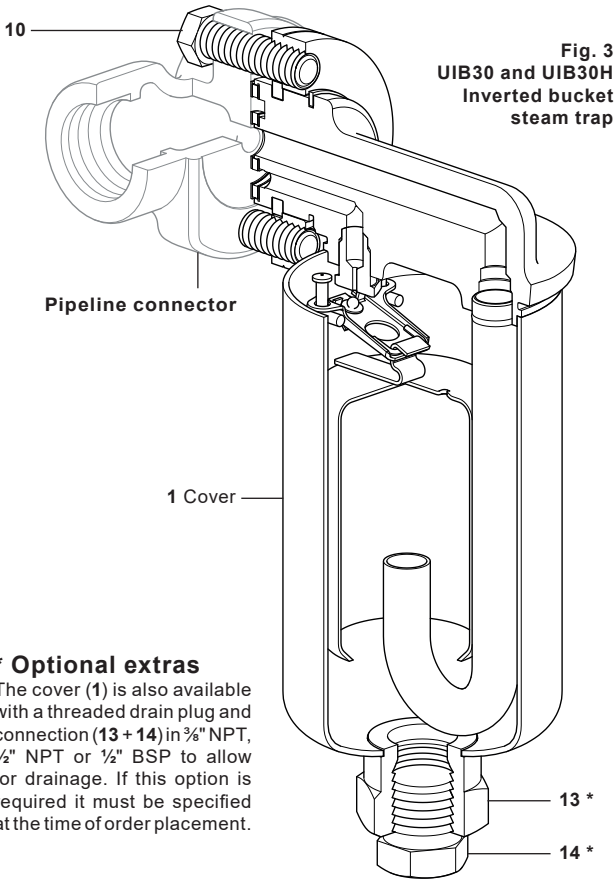
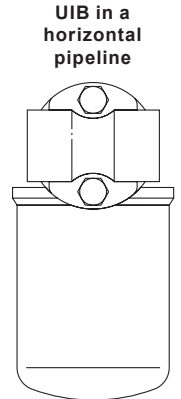
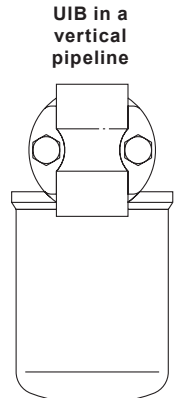

Fig. 3
UIB30 and UIB30H
Inverted bucket
steam trap



UIB in a
horizontal
pipeline





UIB in a
vertical
pipeline

Fig. 2

*** Optional extras**

The cover (1) is also available with a threaded drain plug and connection (13 + 14) in 3/8" NPT, 1/2" NPT or 1/2" BSP to allow for drainage. If this option is required it must be specified at the time of order placement.

Table 1 Recommended tightening torques

Item	Part	 or 	N m	(lbf ft)
10	Connector screws	9/16"	30 - 35	(22 - 26)

4. Commissioning

After installation or maintenance ensure that the system is fully functioning. Carry out tests on any alarms or protective devices.

5. Operation

As condensate reaches the trap it forms a water seal inside the body. The weight of the bucket keeps the valve off its seat. Condensate can then flow around the bottom of the bucket and the trap. Under low load or superheat conditions the trap may need to be 'primed' with water before system start-up. When steam enters the underside of the bucket it gives it buoyancy and the bucket rises allowing the valve to seat and stop steam escaping.

The bucket will lose its buoyancy as the enclosed steam condenses due to radiation losses and steam escapes through the vent hole. Once this happens the weight of the bucket will pull the valve off its seat and the cycle is then repeated.

Any air reaching the trap will also give the bucket buoyancy and close the valve preventing condensate flow. The small vent hole in the bucket will bleed air into the top of the trap. The vent hole is of small diameter to reduce steam loss and will consequently vent air very slowly.

Under most conditions the trap will discharge condensate with a blast type action. Under low load and/or low pressure applications the discharge may tend to 'dribble'. Condensate is discharged at steam temperature consequently due care must be given to the site of the discharge.

6. Maintenance

Note: Before actioning any maintenance programme observe the 'Safety information' in Section 1.

Warning

The inner and outer gaskets used when installing/ maintaining the UIB to a PC_ pipeline connector contain thin stainless steel support rings which may cause physical injury if not handled and disposed of carefully.

6.1 General information

Before undertaking any maintenance on the trap it must be isolated from both the supply line and return line and any pressure allowed to safely normalise to atmosphere. The trap should then be allowed to cool. When reassembling, ensure that all joint faces are clean.

6.2 Replacement of the trap unit:

- Ensure that the correct tools and necessary protective equipment are used at all times.
- Replacement of the trap unit is achieved by removing the two connector screws (**10**) and removing the trap.
- Always use new connector screws, as supplied with the new trap, when replacing a universal trap.
- The new trap unit should be positioned against the connector gasket face and apply a suitable amount of anti-seize thread lubricant to the threads of the connector screws.
- Tighten screws finger tight and ensure that the trap body is parallel to the connector.
- Tighten the screws evenly and gradually to the recommended torque (see Table 1).
- Open isolation valves slowly until normal operating conditions are achieved.
- Check for leaks.

7. Spare parts

The UIB and UIB30H are sealed non-maintainable trap units. No internal spares are available. The spares which are available are shown in heavy outline. Parts shown in a grey line are not supplied as spares.

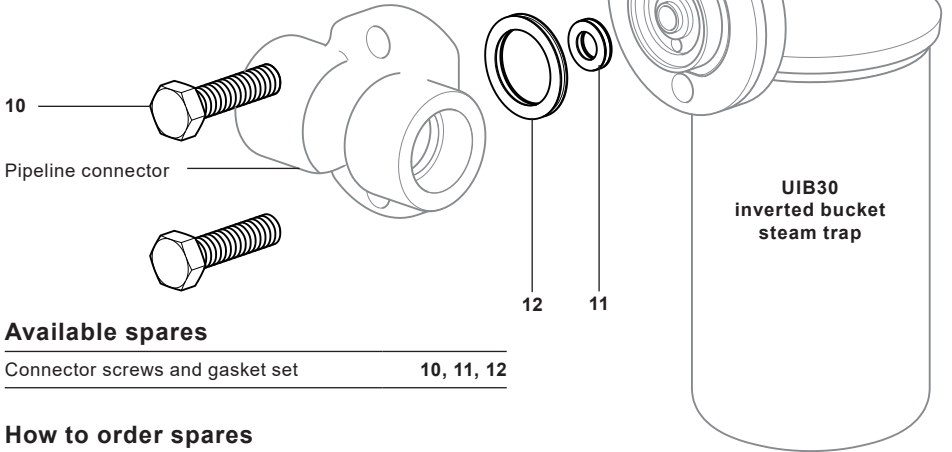

Available spares

Connector screws and gasket set	10, 11, 12
---------------------------------	------------

How to order spares

Always order spare parts by using the description given in the column headed 'Available spares' and state the size, model no. and pressure rating of the trap.

Examples:

1 - Connector screw and gasket set for a Spirax Sarco UIB30 sealed stainless steel bucket steam trap (for use with pipeline connectors).

Table 1 Recommended tightening torques





Item	Part	 or mm		N m	(lbf ft)
10	Connector screws	9/16"		30 - 35	(22 - 26)

Table 2 Dimensions of the optional drain connection - See Fig. 1

Item	Part	 or mm	
13	Drain connection	32 A/F	
14	Drain plug	18 A/F	3/8" NPT
		22 A/F	1/2" NPT
		22 A/F	1/2" BSP

UIB30 and UIB30H Sealed Inverted Bucket Steam Traps for use with Pipeline Connectors

